

# ASSEMBLY INSTRUCTIONS

## STRATUS 5' BED

**IMPORTANT: READ THESE INSTRUCTIONS CAREFULLY BEFORE ATTEMPTING TO ASSEMBLE OR USE YOUR STRATUS 5' BED.**

**PLEASE KEEP THESE INSTRUCTIONS FOR FUTURE REFERENCE**

**HEALTH & SAFETY:**

DO NOT jump on this bed frame  
DO NOT use this bed frame if any parts are missing, damaged or worn  
DO NOT use this bed frame unless all fixings are tightly secured  
Always use on a level, even surface

**WARNING:** IF THIS BED FRAME IS ON A LAMINATED FLOOR YOU MUST PLACE SOME PROTECTION UNDER ALL LEGS TO STOP THE BED FRAME FROM MOVING. IF THIS IS NOT ADHERED TO THERE IS NO GUARANTEE IF THE BED FRAME COLLAPSES.

**CARE & MAINTENANCE:**

Periodically check all screws & fixings to ensure they are tightly secured  
DO NOT push the bed frame as this will damage the legs.  
Always lift the bed with 2 people whenever you need to change the bed frames position  
Keep any sharp objects away from the bed frame

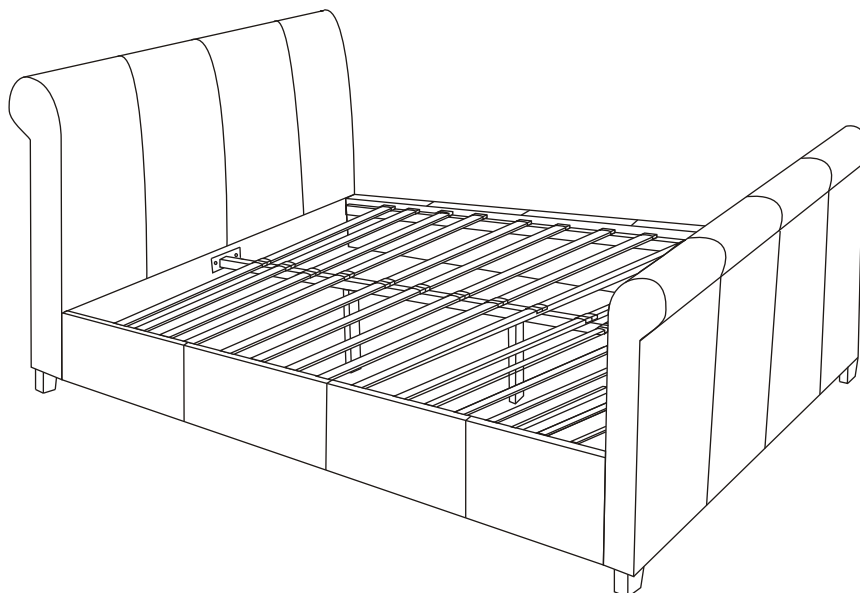

[WWW.BIRLEA.COM](http://WWW.BIRLEA.COM)

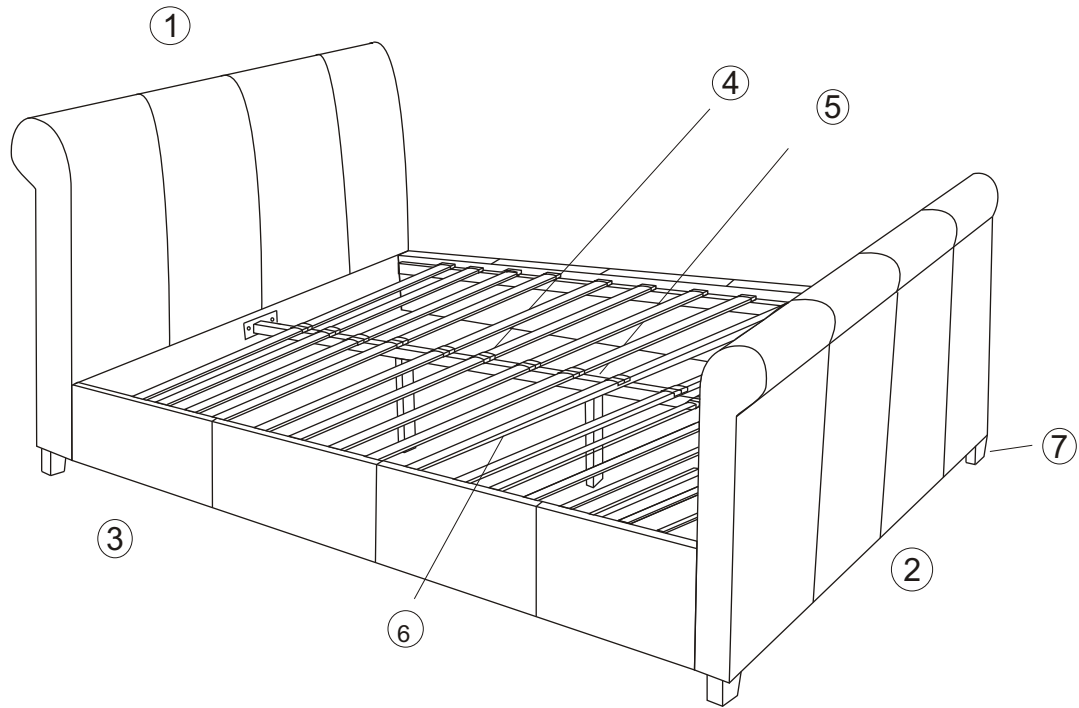

PARTS LIST				HARDWARE LIST (Found in box 3)			
No	Item	Box	Qty	No			Qty
1	Headboard	1	1	A	Bolts (M8 x 30mm)		12
2	Footboard	3	1	B	Nuts (M8 x 13mm)		4
3	Side Rails	2	2	C	Spring Washer		8
4	Centre rail	2	1	D	Flat Washer		8
5	Support Legs	3	2	E	M5 Allen Key		1
6	Slats	3	28	F	Spanner		1
7	Legs	3	4	G	Bolts (M8 x 70mm)		4
				H	Single Plastic Cap		28
				I	Double Plastic Cap		14
				J	Bolts (M8 x 40 mm)		4
				K	Screw		4

**Step 1:**

To fix the legs (7) to the headboard (1) and footboard (2) you will need to use hardware parts E, K and G.

**DO NOT use any power tools, this may damage the bed frame and will invalidate any claims.**

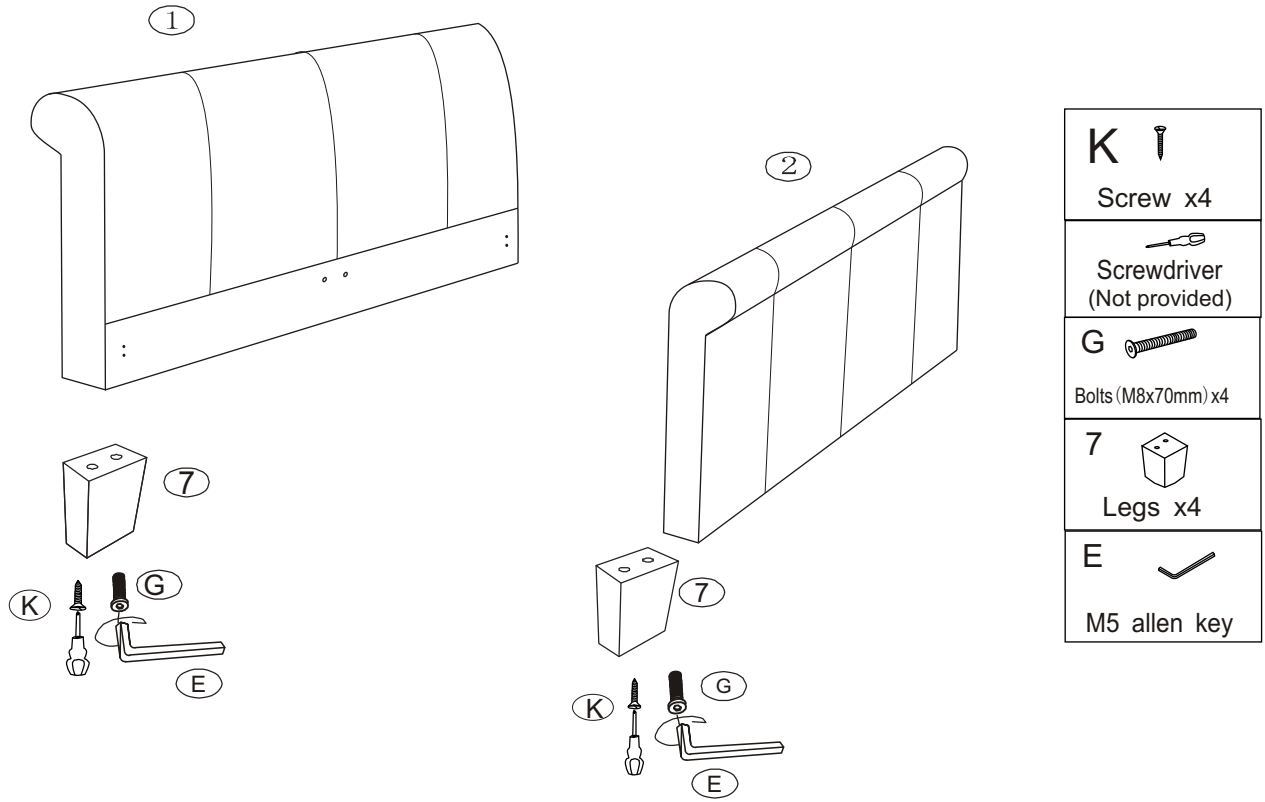

**Step 2:**

To fix the support legs (5) to the centre rail (4) you will need to use hardware parts B and J.

**You will need to use the M5 allen Key (E) and the spanner (F) as provided for this step of the assembly.**

**DO NOT use any power tools as this may damage the frame and will invalidate any claims.**

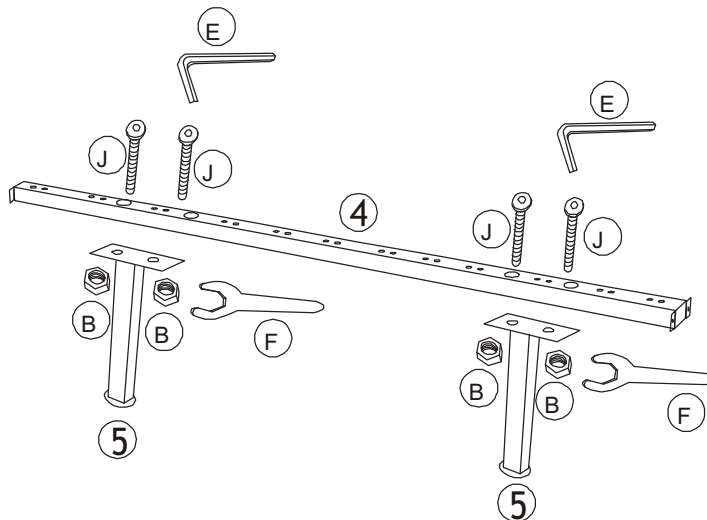

**Step 3:**

To attach the side rails (3) to the headboard (1) and the footboard (2) you will need to use hardware parts A, C and D with the M5 allen key (E).

To attach the centre rail (4) to the headboard (1) and the footboard (2) you will need to use hardware parts A and the M5 allen key (E).

**DO NOT use any power tools as this may damage the frame and will invalidate any claims.**

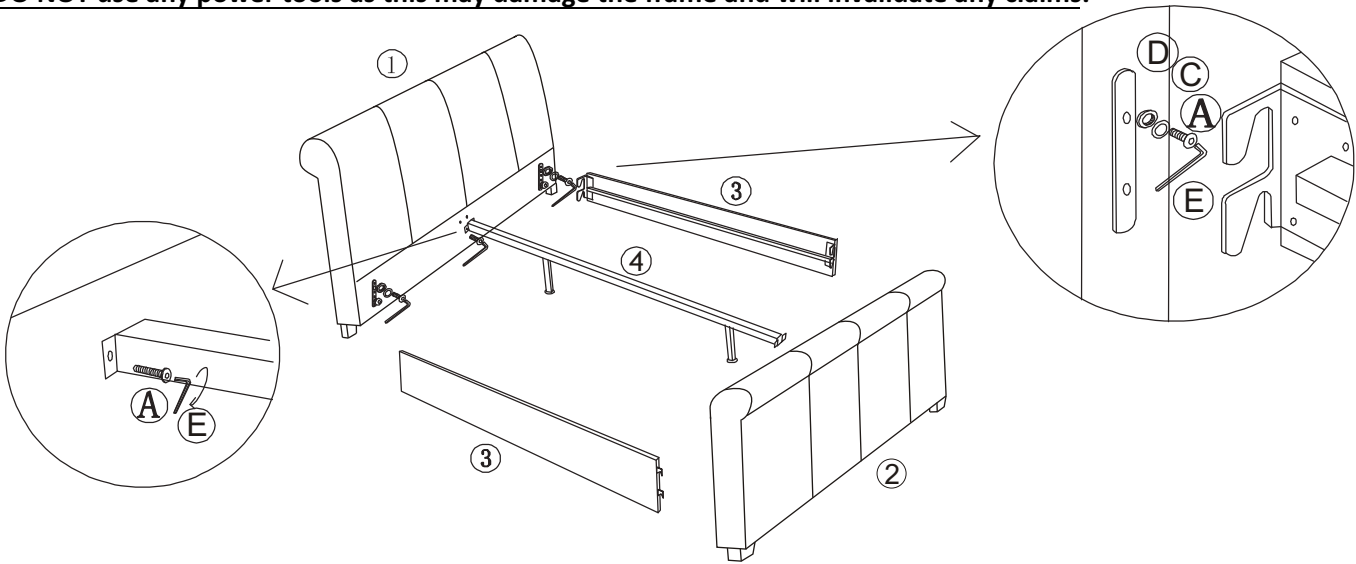
**Step 4:**

Assemble the slats (6) as shown in the diagrams below then push all of the plastic cap's firmly into the side rails (3) and centre rail (4).

**DO NOT use any power tools as this may damage the frame and will invalidate any claims.**

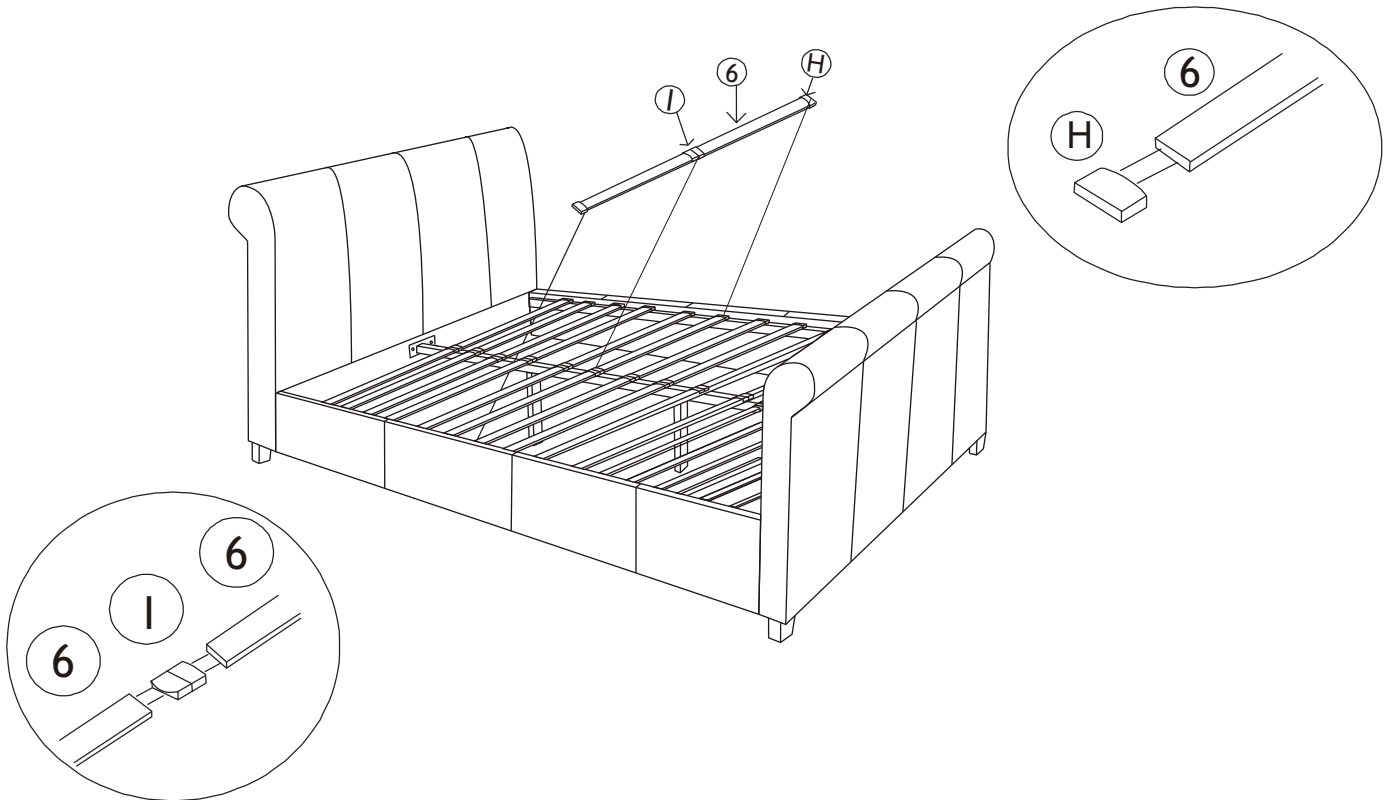
**Additional Information:**

- For complete product information, images and dimension diagrams please visit the website [www.birlea.com](http://www.birlea.com)
- If you have any issues with your item please contact the retailer directly you purchased it from who will be able to resolve any issues with Birlea.
- Why don't you send us photos of your assembled furniture to [info@birlea.com](mailto:info@birlea.com) to be shared in our #birleahome feature on Instagram.