



Birlea

Suppliers of inspiration

Vendor: S000013

PO: F02213



ASSEMBLY INSTRUCTIONS 150CM CASTELLO BED STEEL CRUSHED VELVET

IMPORTANT : READ THESE INSTRUCTIONS CAREFULLY BEFORE ASSEMBLING OR USING YOUR 150CM CASTELLO BED STEEL CRUSHED VELVET

PLEASE KEEP THESE INSTRUCTIONS FOR FUTURE REFERENCE.

HEALTH & SAFETY:

DO NOT jump on this bed frame.

DO NOT use this bed frame if any parts are missing, damaged or worn.

DO NOT use this bed frame unless all fixings are secured.

Please keep small parts out of reach of children.

Always use on a level, even surface.

WARNING : If this bed is placed on a non- carpeted floor you must place some protection under all legs to stop the bed frame from moving. if this is not adhered to there is no guarantee if the bed frame collapses.

CARE & MAINTENANCE:

Assembly in the room use.

Periodically check all screw & fixings to ensure they are secure.

DO NOT push the bed frame as this will damage the legs.

Always lift the bed with two people to reposition.

Keep any sharp objects away from the frame.

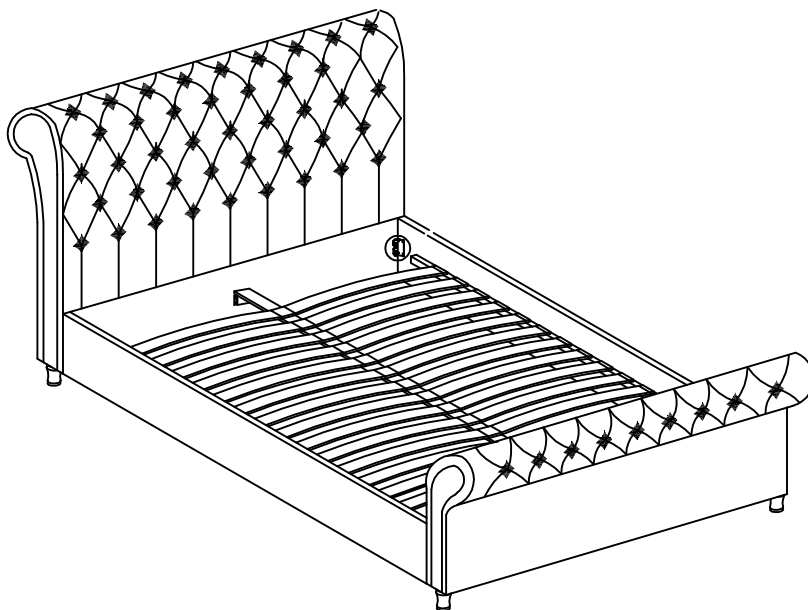

Birlea







Suppliers of inspiration

www.birlea.com

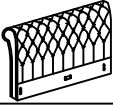
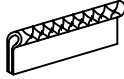



Page 1 of 4

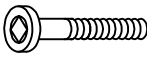
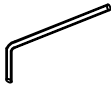
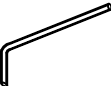
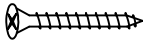

Parts List

Parts	Description	Box	Qty
1	Headend 	1	1
2	Footend 	2	1
3	Side Rail 	3	2
4	Legs 	1	4
5	Slat 	1	28
6	Centre Rail 	3	1
7	Support Leg 	1	2

Hardware List (Found in box 1)

Parts	Description	Box	Qty
A	M6 x 40 mm JCBC 	1	2
B	Allen Key M4 x 65 mm 	1	1
C	Allen Key M5 x 70 mm 	1	1
D	M4 x 25 mm CSK 	1	2
E	Double Slat Cap 	1	14
F	Single Slat Cap 	1	28
G	Adjuster 	1	2

*You will need a screwdriver (not provided)





Birlea

Suppliers of inspiration

Vendor: S000013



Step 1: Attach the legs (4) to the headend (1) and footend (2).

DO NOT use any power tools as this may damage the frame and will invalidate any claim.

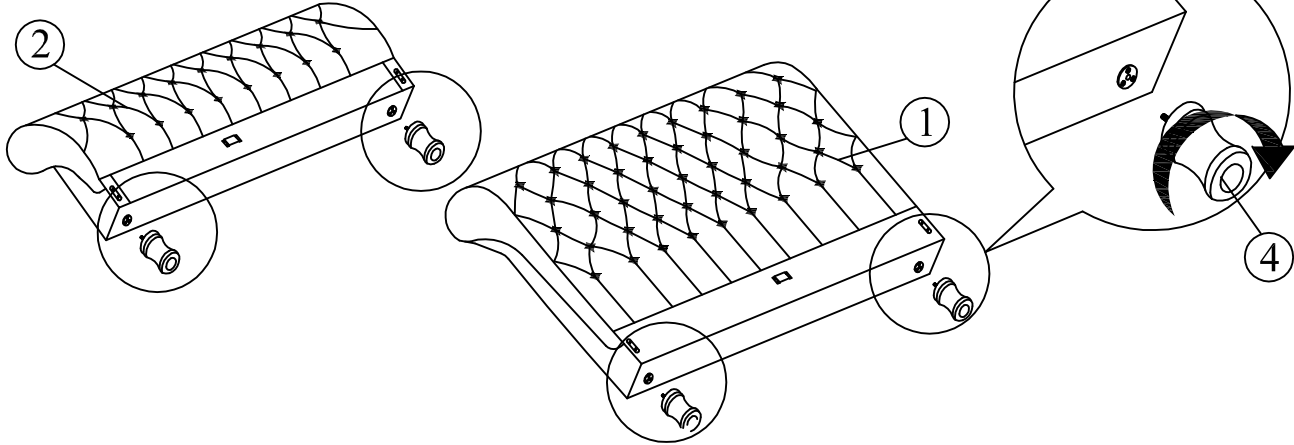

Step 2: Attach the side rails (3) by pushing the brackets down into place as shown.

DO NOT use any power tools as this may damage the frame and will invalidate any claim.

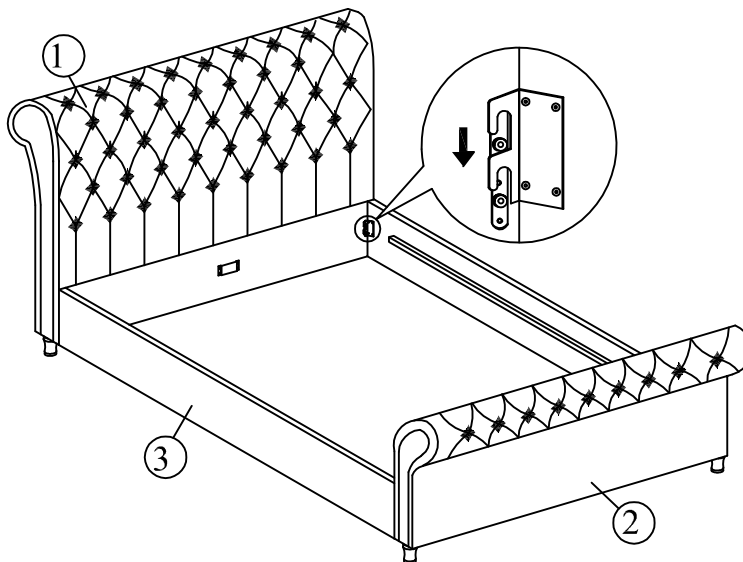

Step 3: Attach the support legs (7) to the centre rail (6) using hardware parts A and B.

DO NOT use any power tools as this may damage the frame and will invalidate any claim.

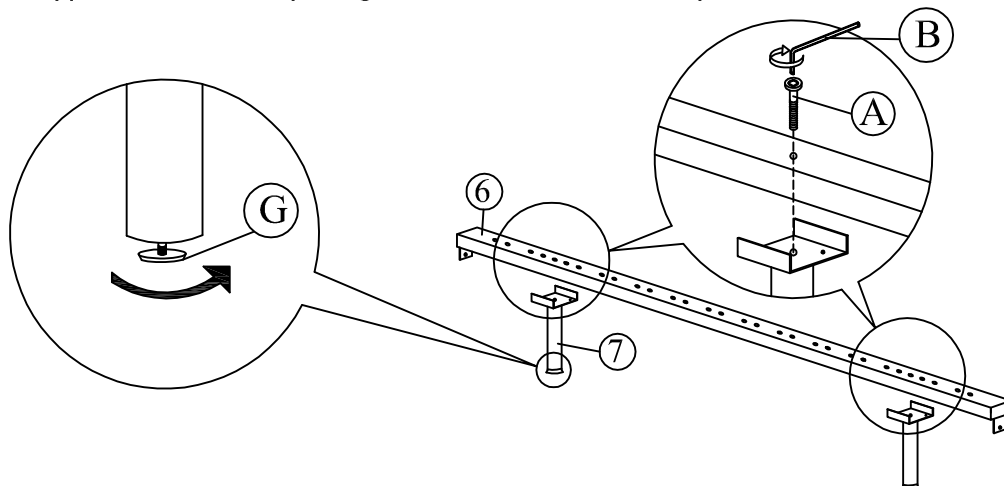

Birlea

Suppliers of inspiration

www.birlea.com

Page 3 of 4



Birlea

Suppliers of inspiration

Vendor: S000013



Step 4: Insert the centre rail (6) to the headboard (1) and footboard (2) and secure using hardware part D and a screwdriver (not provided).

DO NOT use any power tools as this may damage the frame and will invalidate any claim.

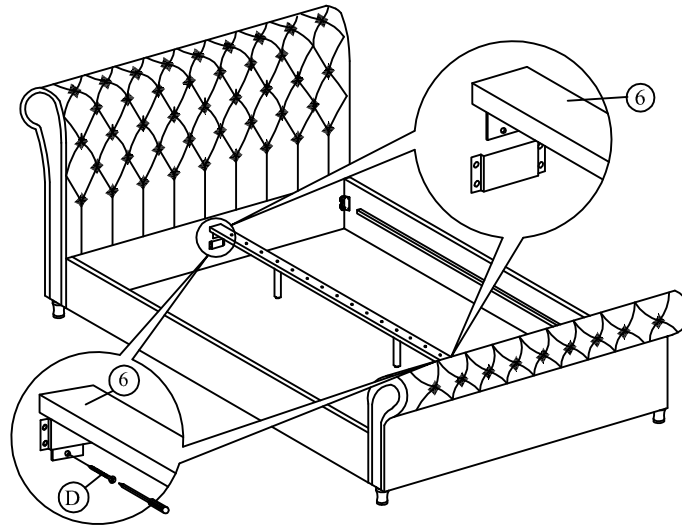

Step 5: Attach the slats (5) using hardware parts E and F then secure the bolts using hardware part C.

DO NOT use any power tools as this may damage the frame and will invalidate any claim.

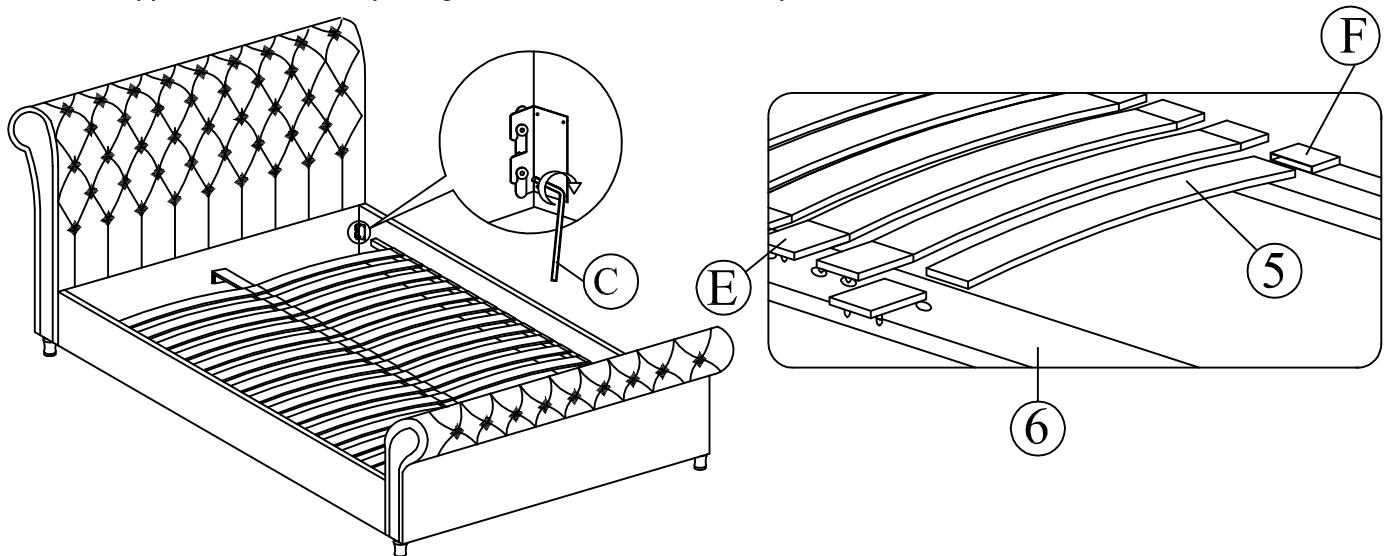

Additional Information:

- For complete product information, images and dimension diagrams please visit the website www.birlea.com
- If you have any issues with your item please contact the retailer directly you purchased it from who will be able to resolve any issues with Birlea.
- Why don't you send us photos of your assembled furniture to info@birlea.com to be shared in our #birleahome feature on Instagram.



Birlea

Suppliers of inspiration

www.birlea.com

Page 4 of 4